

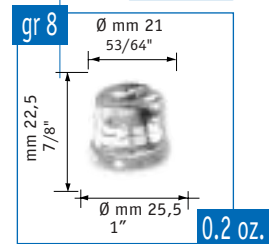

- AC 25
- AC 45
- AC 55
- AC 85
- AC 105
- AC 125**
- AC 175
- AC 225

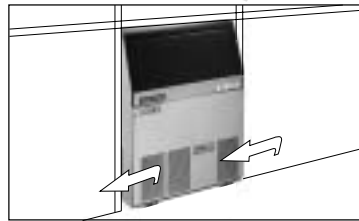

AC S 125

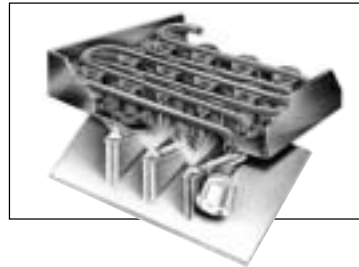
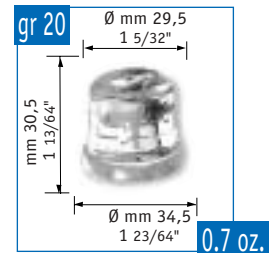

AC M 125

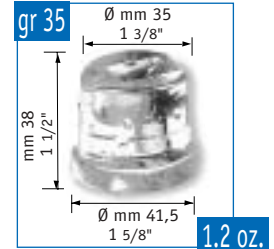

AC L 125

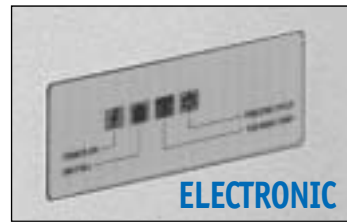

**Automatic
Gourmet-Cube
Ice Machine**

**Machine
Automatique
à Glaçons
Gourmet**

**Automatischer
Gourmetkegel-
eisbereiter**

**Màquina
Automàtica
Fabricadora
de Cubitos
Gourmet**

**Produttore
Automatico
di Ghiaccio
a Cubetti
Gourmet**

	[kg] [lbs]	N°	[kg] [lbs]	N°	[v/Hz/ph]	[HxWxD mm]	[HxWxD inches]	[H mm] [H inches]	R
AC S 125 A	64 140	8000	28 62	3500	230/50/1	897x675x521	35 5/16"x26 9/16"x20 8/16"	H=897+120 3511/32"+412/16"	R 134 a
AC S 125 W	67 147	8375	28 62	3500	230/50/1	897x675x521	35 5/16"x26 9/16"x20 8/16"	H=897+120 3511/32"+412/16"	R 134 a
AC M 125 A	71 156	3550	28 62	1400	230/50/1	897x675x521	35 5/16"x26 9/16"x20 8/16"	H=897+120 3511/32"+412/16"	R 134 a
AC M 125 W	74 163	3700	28 62	1400	230/50/1	897x675x521	35 5/16"x26 9/16"x20 8/16"	H=897+120 3511/32"+412/16"	R 134 a
AC L 125 A	67 147	1915	28 62	800	230/50/1	897x675x521	35 5/16"x26 9/16"x20 8/16"	H=897+120 3511/32"+412/16"	R 134 a
AC L 125 W	70 154	2000	28 62	800	230/50/1	897x675x521	35 5/16"x26 9/16"x20 8/16"	H=897+120 3511/32"+412/16"	R 134 a

2

**Years Warranty
Ans de Garantie
Jahre Garantie
Años de Garantía
Anni di Garanzia**

Subject to certain limitations and exclusions
Assujettie aux limites et exclusions prescrites
Abhängig von Bestimmten Einschränkungen und Ausnahmen
Sujeta a algunas limitaciones y exclusiones
Soggetta ad alcune limitazioni ed esclusioni



This product qualifies for the following listings:



AC 125

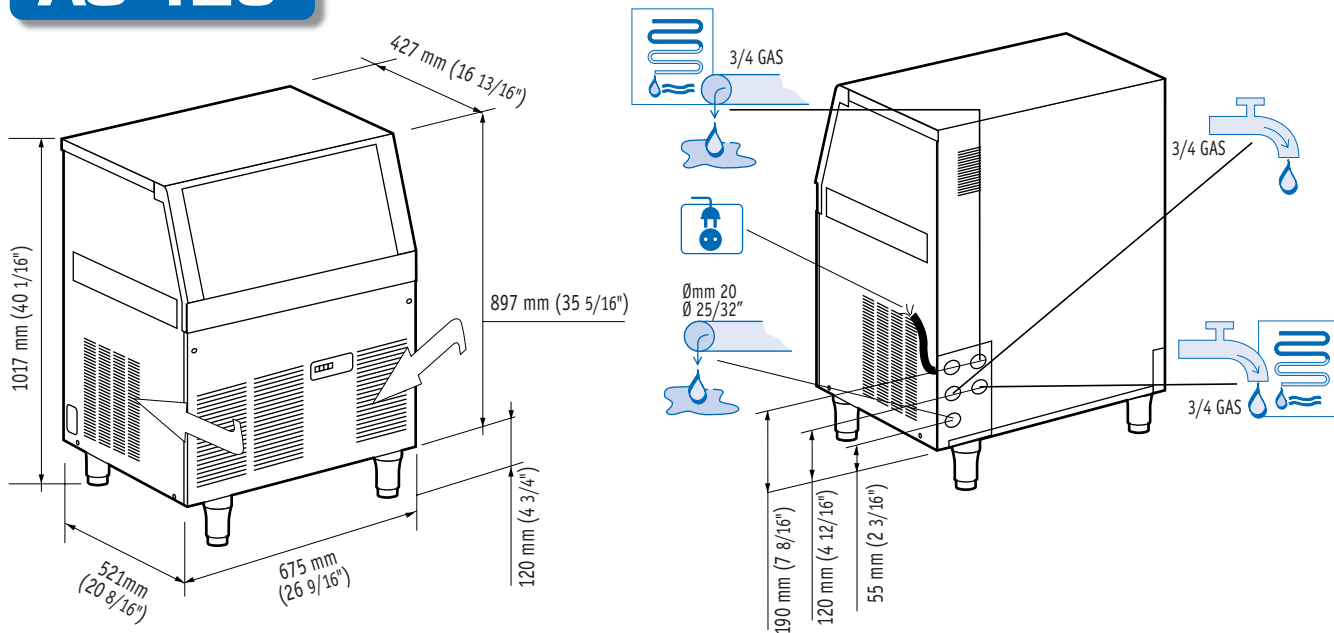

	+C° -C°	[Btu/h] [kcal/h]	[Ømm]	[W]	FUSE	[kWh] 24h	[L/h]	[gal/h]	[kg]	[lbs]	[kg]	[lbs]
AC S 125 A		5350 1570	3 x 1,5	670	10 A	13	6,5	1,7	55	120	65	143
AC S 125 W		5350 1570	3 x 1,5	670	10 A	13	45	12	54	118	64	141
AC M 125 A		5350 1570	3 x 1,5	670	10 A	13	6,5	1,7	55	120	65	143
AC M 125 W		5350 1570	3 x 1,5	670	10 A	13	45	12	54	118	64	141
AC L 125 A		5350 1570	3 x 1,5	670	10 A	13	6,5	1,7	55	120	65	143
AC L 125 W		5350 1570	3 x 1,5	670	10 A	13	45	12	54	118	64	141

ACM 125 AIR



°F	50°	60°	70°	90°	
°C	10°	15°	21°	32°	
10°	71	69	68	65	kg
50°	156	152	150	143	lbs
21°	68	67	65	62	kg
70°	150	147	143	136	lbs
32°	59	57	56	53	kg
90°	130	125	123	117	lbs
38°	53	52	50	47	kg
100	117	114	110	103	lbs

24h



Machine requires voltage indicated on rating name plate. Failures caused by improper voltage are not considered factory defects. Scotsman products are not designed for outdoor installation. Extended periods of operation at temperatures exceeding the above limitations constitutes misuse under the terms of Scotsman Limited Warranty, resulting in a loss.

La machine doit être raccordée conformément au voltage indiqué sur la plaque signalétique. Les éventuels dégâts causés par un non respect de cette consigne ne peuvent être considérés comme des défauts de fabrication. Les machines à glace Scotsman ne sont pas conçues pour être utilisées à l'extérieur. Le fonctionnement prolongé à des températures supérieures ou inférieures aux limites ci-dessus sont considérées comme une mauvaise utilisation dans le cadre de la garantie Scotsman.

ACM 125 WATER



°F	50°	60°	70°	90°	
°C	10°	15°	21°	32°	
10°	74	72	69	64	kg
50°	163	158	152	141	lbs
21°	72	70	67	62	kg
70°	158	154	147	136	lbs
32°	69	66	64	59	kg
90°	152	145	141	130	lbs
38°	65	62	60	55	kg
100	143	136	132	121	lbs

24h



Der Eisbereiter benötigt eine Stromspannung gemäß Geräte-Typenschild. Störungen oder Ausfälle, durch den Betrieb mit falscher Stromspannung sind keine Fabrikationsfehler und fallen nicht unter Garantie. Scotsman Eisbereiter sind nicht für die Installation im Freien geeignet. Der längere Betrieb bei Temperaturen über den obigen Grenzwerten ist eine falsche Anwendung und bedeutet den Verlust der Garantieleistung.

Los requerimientos eléctricos de la máquina están indicados en la placa de características. Los daños causados por voltajes inadecuados no son considerados defectos de fábrica. La máquina de hielo Scotsman, no están diseñadas para trabajar a la intemperie. Largos periodos de funcionamiento a temperaturas que excedan de las limitaciones indicadas, constituyen maltrato de acuerdo con las observaciones de Scotsman.

La macchina richiede il voltaggio indicato sulla targhetta di identificazione. Danni causati da voltaggi diversi non sono considerati difetti di produzione. I prodotti Scotsman non vanno utilizzati all'aperto. Un prolungato periodo di utilizzo al di fuori delle temperature indicate non è consentito e causa l'automatico decadere della garanzia.



Scotsman[®]
Ice Systems

The one the world relies on.

USA, Canada, Central and South America
Scotsman Ice Systems USA
775 Corporate Woods Parkway
Vernon Hills, IL 60061
Ph: (847) 215-4550
Fax (847) 913-9844
E-Mail: customer.service@scotsman-ice.com

Europe, Middle East and Africa
Scotsman Europe - Frimont S.p.A.
Via Puccini, 22
20010 Bettolino di Pogliano (Milano) Italy
Ph: (+39) 02-93960208
Fax: (+39) 02-93960201
E-Mail: scotsman.europe@frimont.it

Asia and Pacific
Scotsman Ice Systems-Frimont S.p.A. (R.O.)
627A Aljunied Road-#04-04 Biztech Centre
Singapore 389842
Ph: (+65) 6738 5393-Fax: (+65) 6738 1959
E-mail (general): scotsice@singnet.com.sg
E-mail (service): scotserv@singnet.com.sg

China
Scotsman Ice Systems
258 Tong Ren Road Golden Tower 7A
Shanghai-200040 Peoples's Republic of China
Ph: (+86) 21-62476056
Fax: (+86) 21-62476126
E-mail: scotsmansh@online.sh.cn

South Africa
Scotsman Ice Systems S.A.Pty: Ltd.
69, Audley Road - 2021 Bryanston
P.o. Box 44 - 2149 Riverclub-S. Africa
Ph: +27-11-4636244/5
Fax +27-11-4631411
E-Mail: scotsman@telkomsa.net

